

## Complete shower room Installation & Operation Manual

H88-842  
SIZE: 80x80x205cm

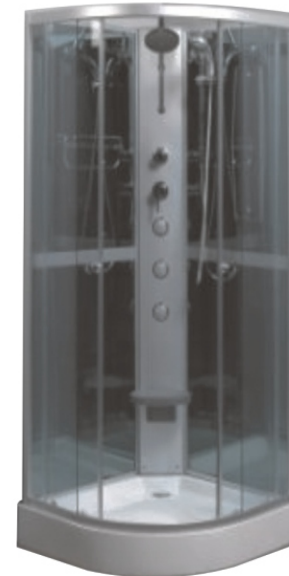

H88-843  
SIZE: 90x90x205cm



H88-844  
SIZE: 100x100x205cm

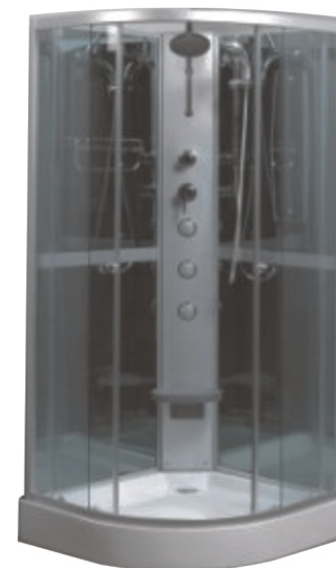

H88-845  
SIZE: 120x80x205cm



## Cautions in Installation and Using

Thanks for selecting our shower room series. To guarantee safe and normal operation as well as prolong service lifetime. Please read Instruction carefully before installation.

Note: We are dedicated to improving products quality, find something new in what is old, we would if there is difference in the Instruction until further notice. Any discomfort, we ask your pardon.



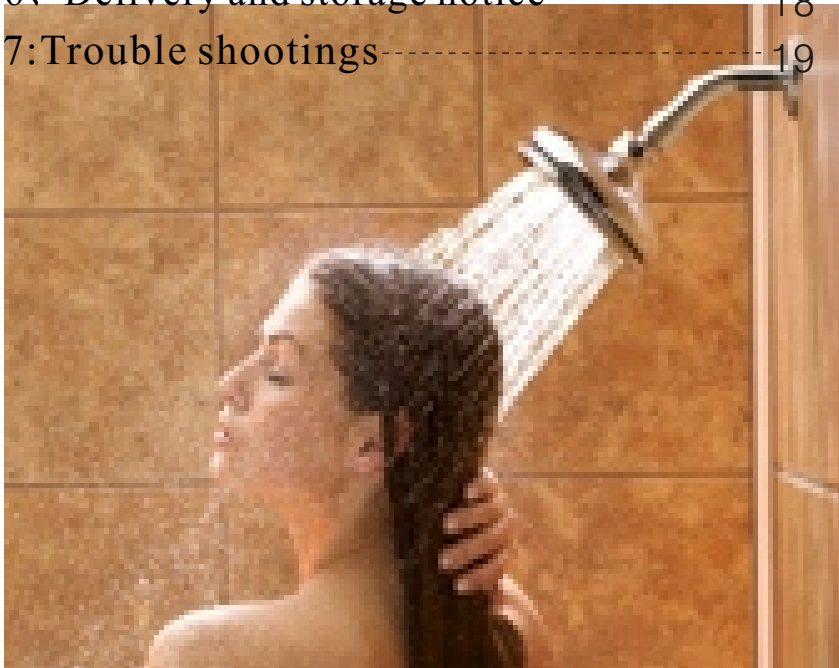

### Directory

1: Tool contents	-----	3
2: Accessory list	-----	4-5
3: Pipe and drain installation drawing	-----	6
4: Installation Procedure	-----	7-17
5: Notes	-----	18
6: Delivery and storage notice	-----	18
7: Trouble shootings	-----	19



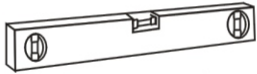

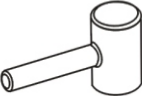
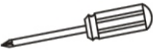

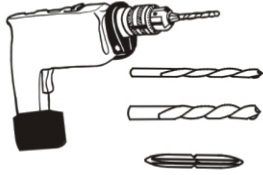





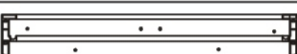

(1)

## 1: self-provide tool

Name	Tool
Track level bar	
tape measure	
Ajustable spanner	
Rubber hammer	
Phillips srewdriver	
Scissors	
Glass cement	
Electric Drill	
3mm aiguille	
5mm aiguille	
tap drill	



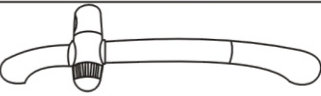









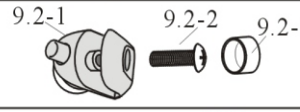

(2)

## 2.Partial accessory list

Item	Name	Accessory	Quantity
1	(1)Tub		1
2	(2.1)Left back board		1
	(2.2)Middle back board		1
	(2.3)Right back board		1
3	(3.1)Side upright column		2
	(3.2)Upper rail		1
	(3.3)Bottom rail		1
4	(4.1)Arch fixed door glass		2
	(4.2)Arch flexible door glass		2
5	(5.1)Head shower syphon		1
	(5.2)Head shower		1
6	(6.1)lifting poker		1
	(6.2)handle shower		1

(3)

## 2.Partial accessory list

Item	Name	Accessory	Quantity
6	(6.3)Hand shower tube		1
	(6.4)Cold and hot water pipe		2
7	circular form knob		2
8	Shelf		1
9	(9.1)Upper wheel		4
	(9.2)Bottom wheel		4
10	(10.1)Magnetic belt		2
	(10.2)Waterproof belt		4
	(10.3)U style thong		2
	(10.4)Glass locator card		8
	(10.5)Glass squeeze head		4
11	(11.1)M4*25mm screw		10
	(11.2)St4*16mm self tapping screw		8
	(11.3)St4*12mm self tapping screw		4
	(11.4)St4*10mm self tapping screw		4

(4)

### 3. Pipe and drain installation drawing

Demension: 90\*90\*218cm

C=Cold water inlet

H=Hot water inlet

D=Drain

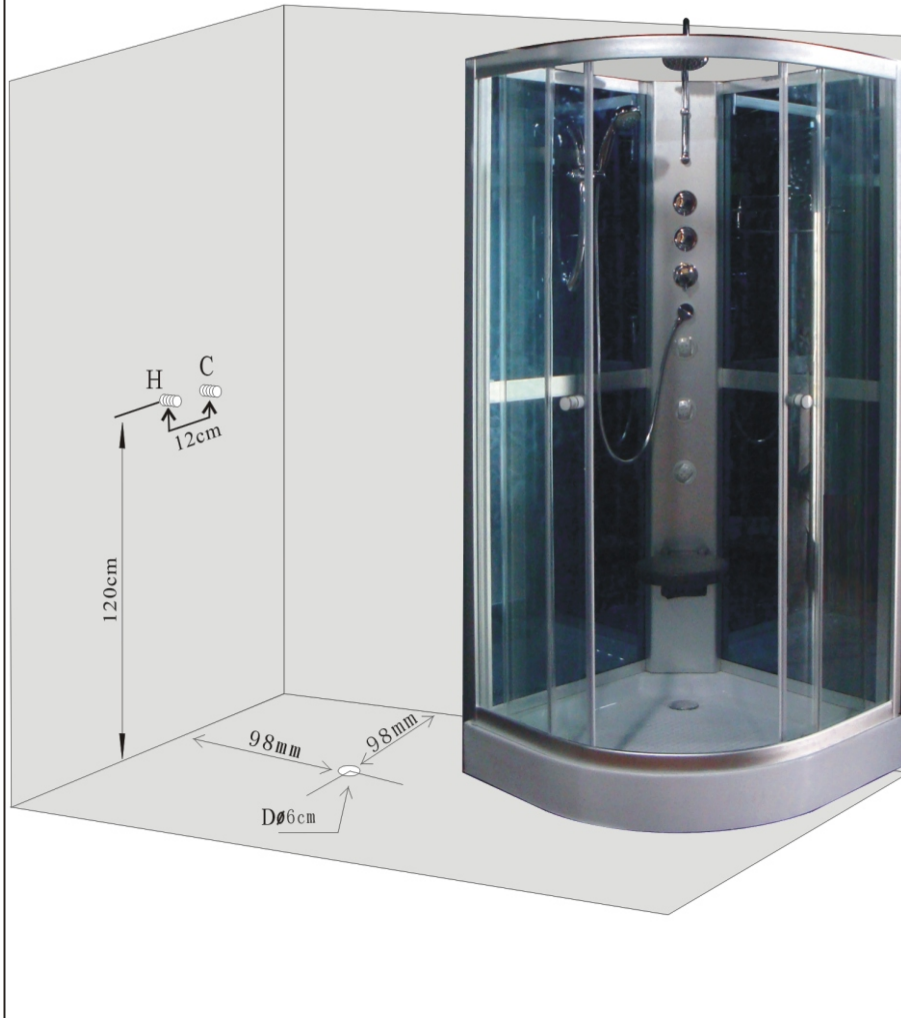

(5)

### 4. Installation Procedure

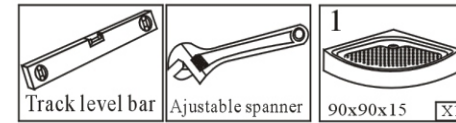

Put track level bar on the tub, and adjust foot's screw by adjustable spanner, and keep it to the leveling

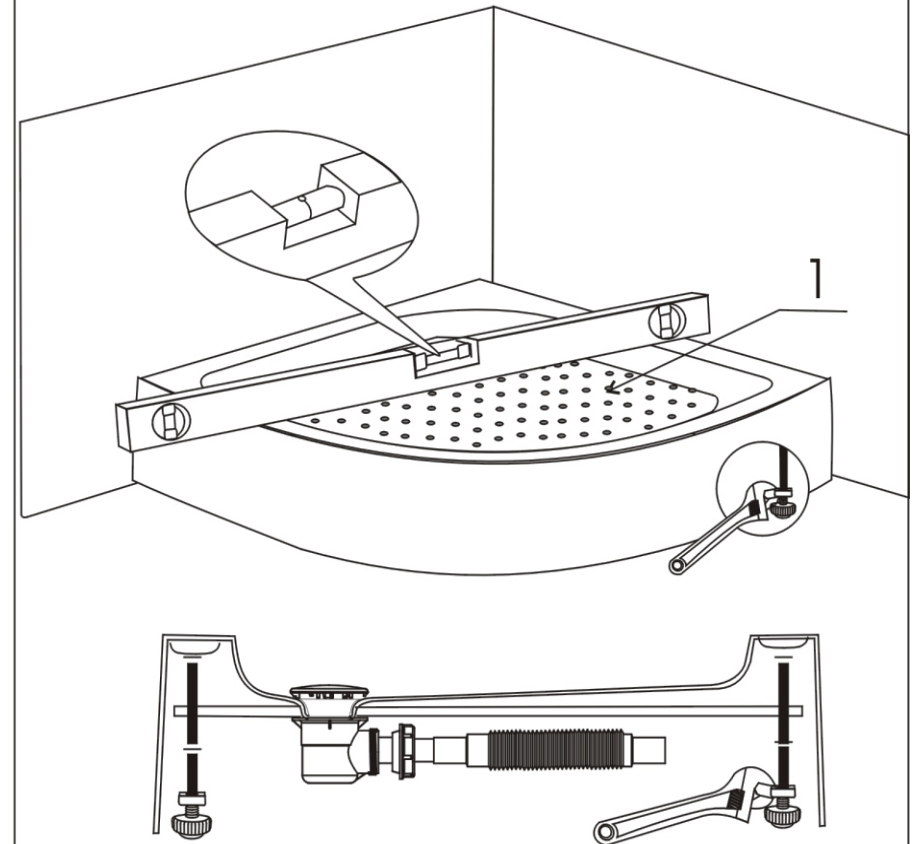

(6)

## 4: Installation Procedure

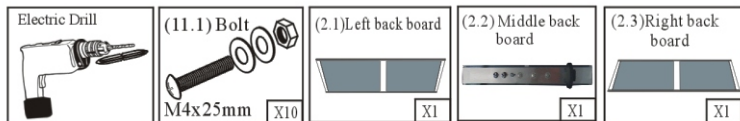

To align three backboards and combine them vertically. Dig holes with 5mm diameter drill bit only hypodispersion Then tighten it with M4\*25mm bolt.

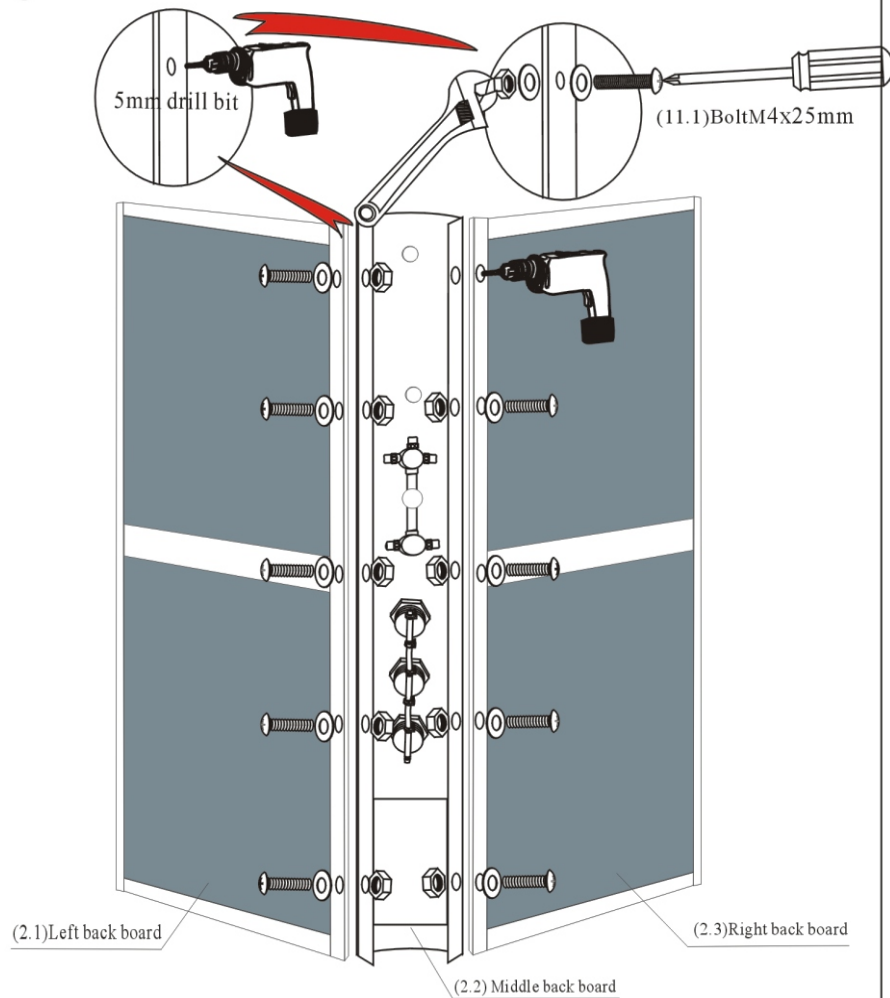

(7)

## 4: Installation Procedure

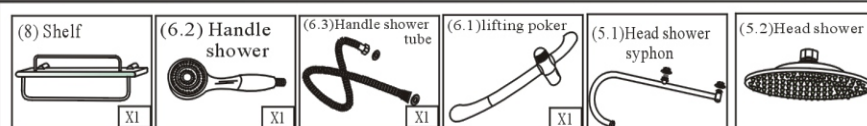

Install relevant accessories to the three pieces of backboard, then connect water pipe accordingly.

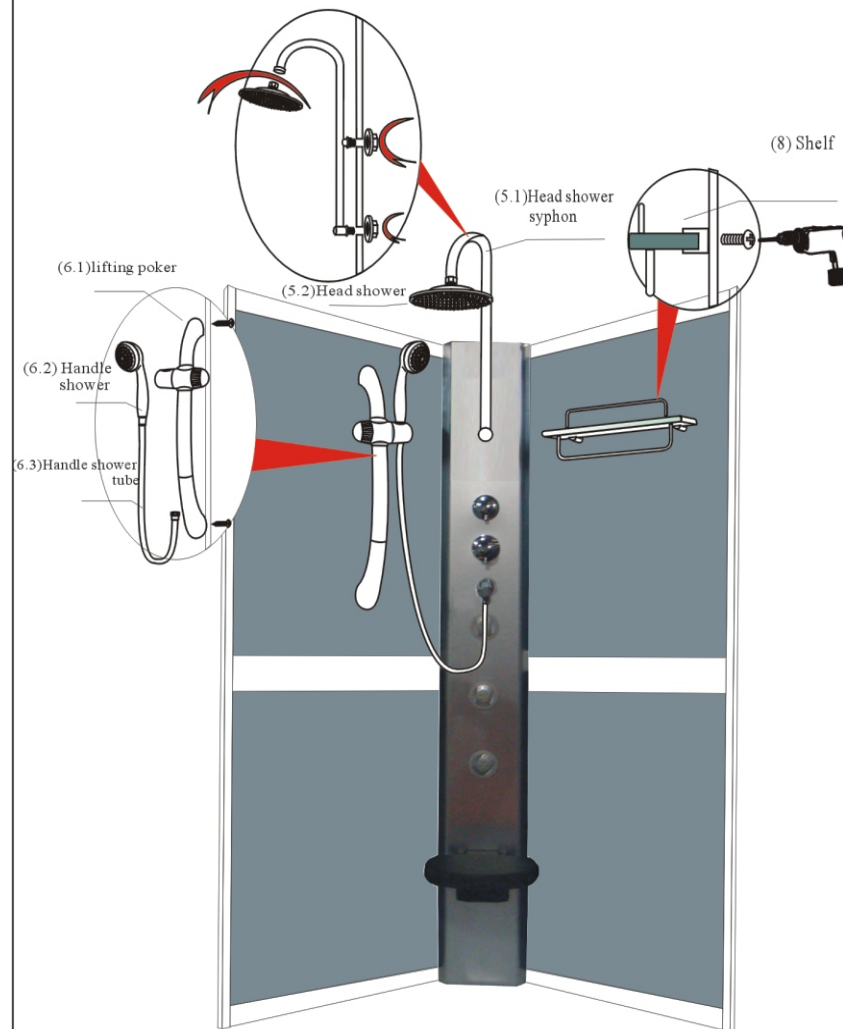

(8)

## 4. Installation Procedure

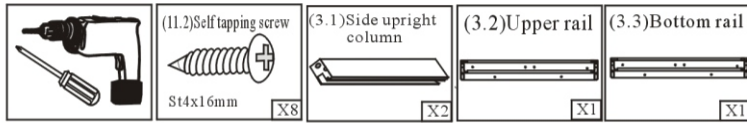

(3.2)-upper rail,(3.3)-bottom rail, connect them by side upright column, tighten them with self tapping screw.

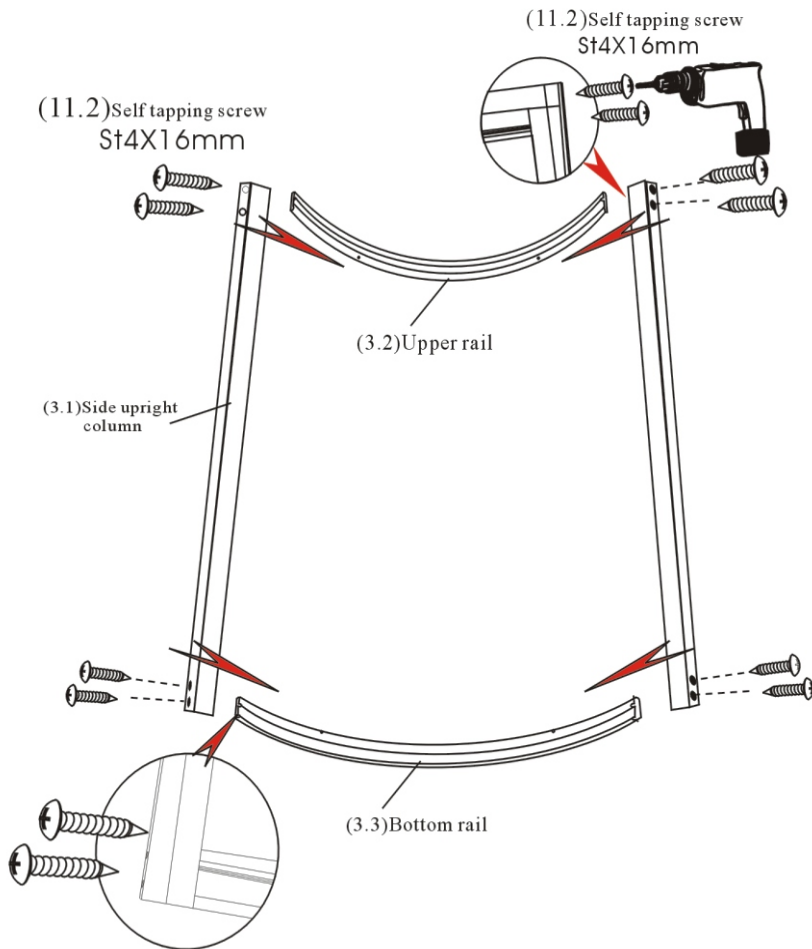

(9)

## 4. Installation Procedure

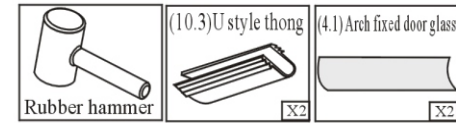

Put U style thong on the arch fixed door glass,insert rail to the side upright column with rubber hammer.

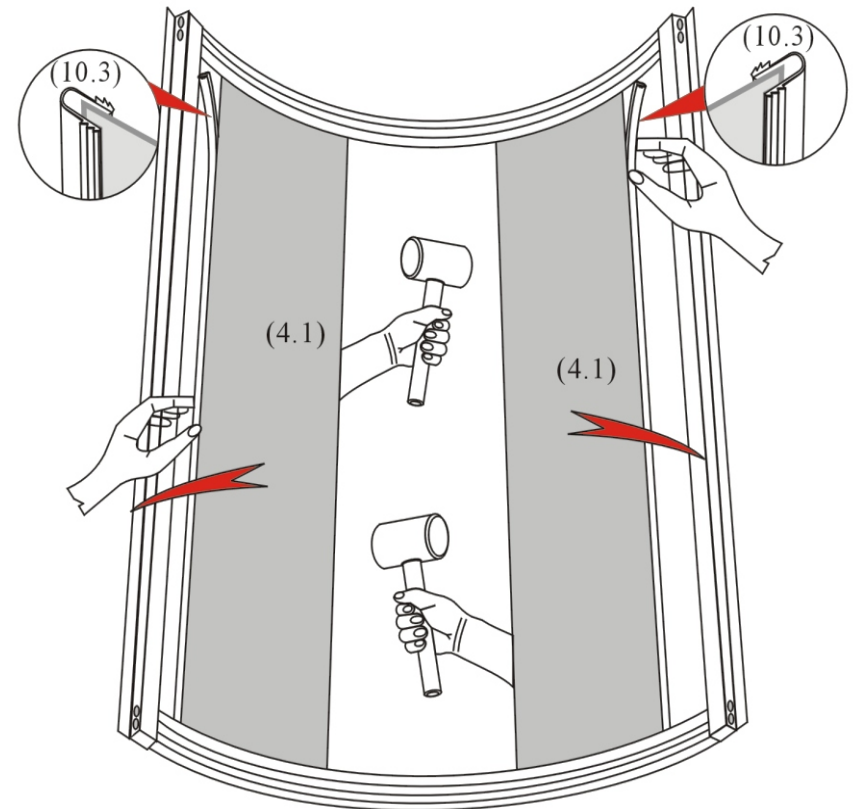

(10)

## 4. Installation Procedure

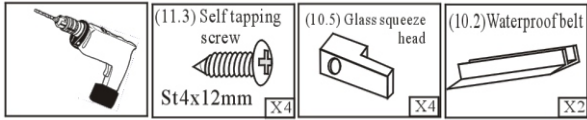

Tighten fixed door glass with self tapping screw and glass squeeze head. Then put waterproof belt.

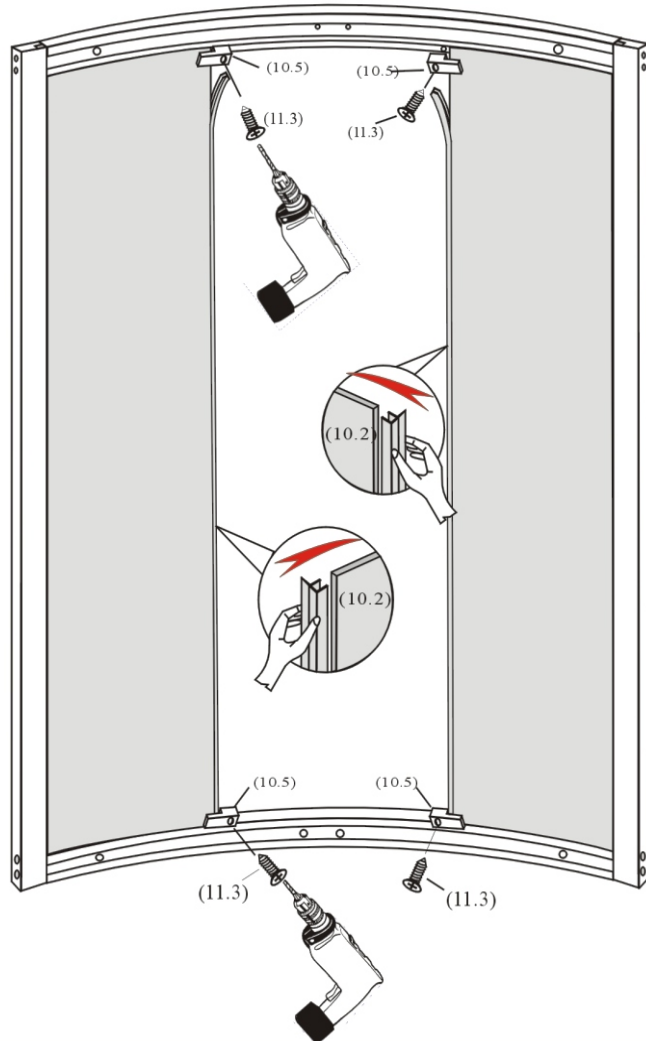

(11)

## 4. Installation Procedure

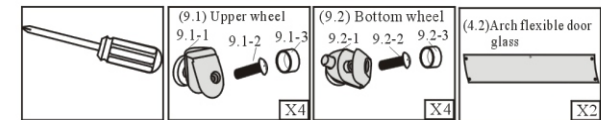

Tighten movable door pocket with screwdriver, put on the decorative nob, then take it on the rails.

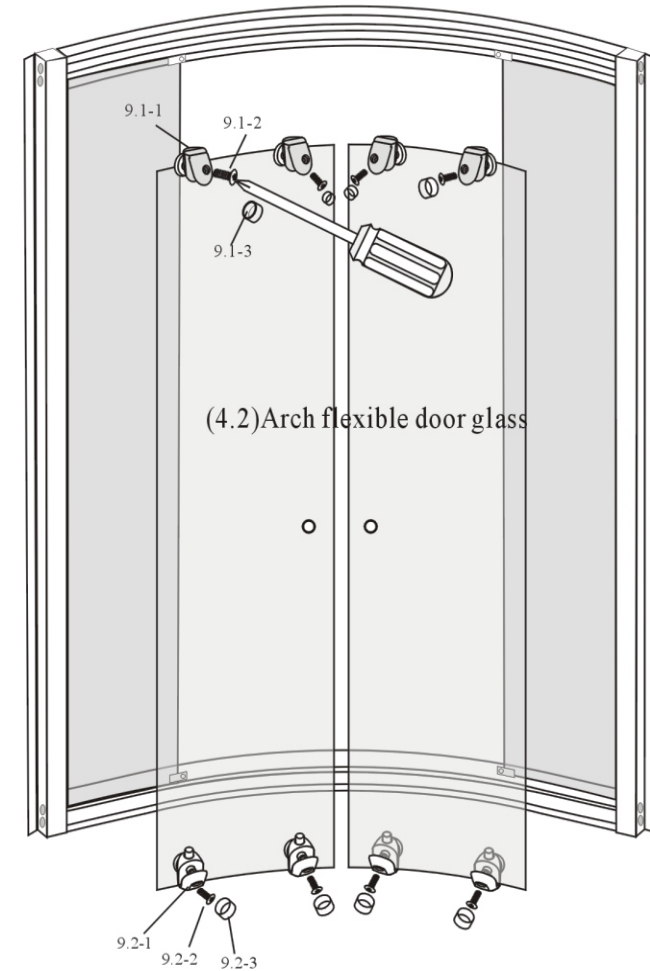

(12)

## 4. Installation Procedure

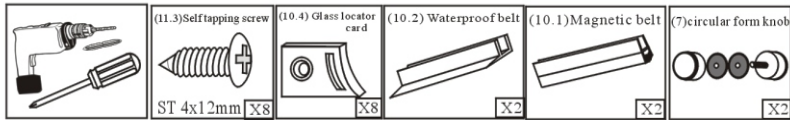

Install knob, tighten with self tapping screws, then install waterproof belt and magnetic belt.

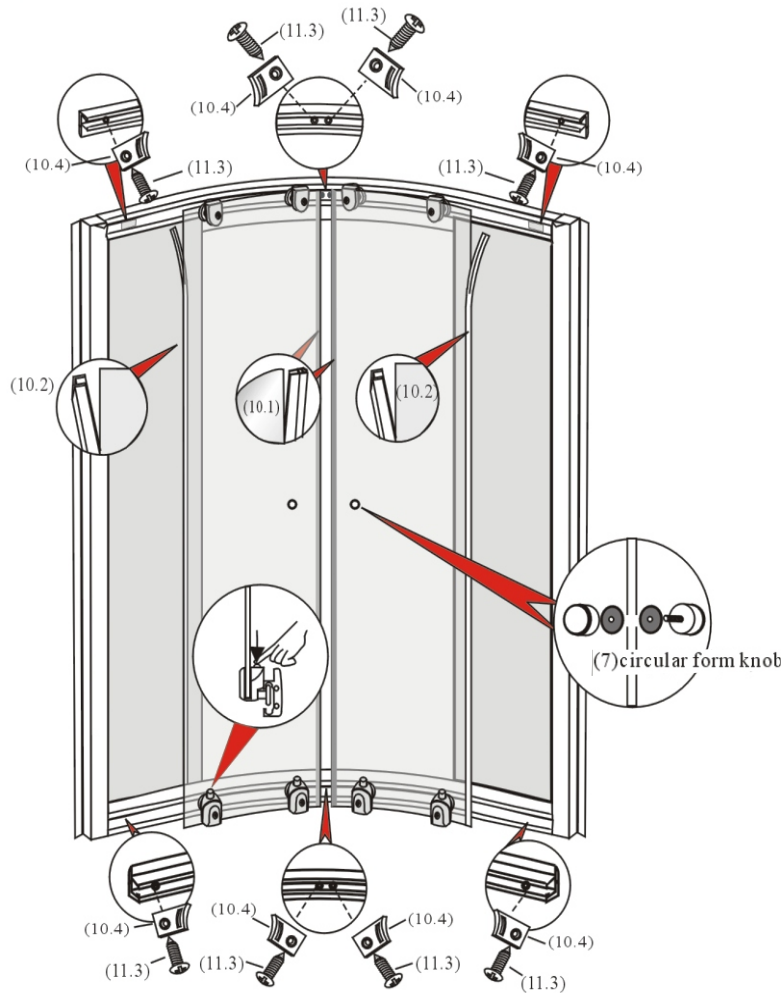

(13)

## 4. Installation Procedure

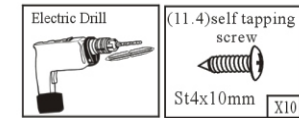

Combine backboard and glass room, dig holes with 3mm diameter drill bit, fasten them with self tapping screws.

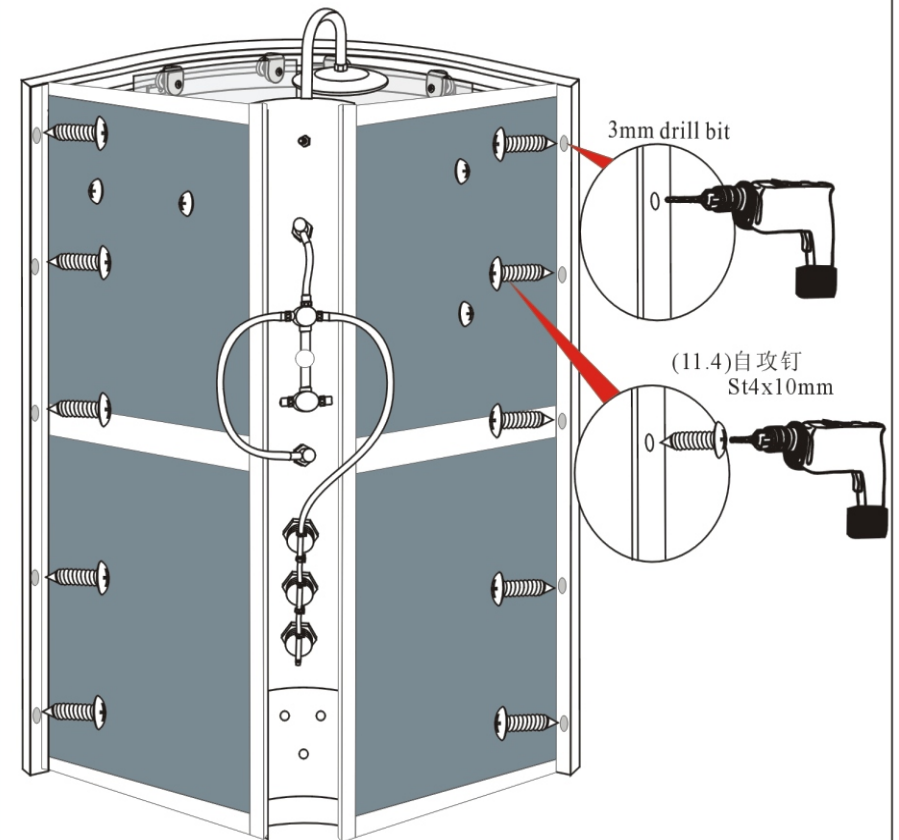

(14)



#### 4. Installation Procedure

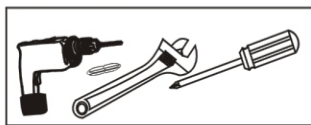

Put backboard and glass room on the tub, adjust the setting position, dig holes with 3mm diameter drill bit, fasten them with self tapping screws.

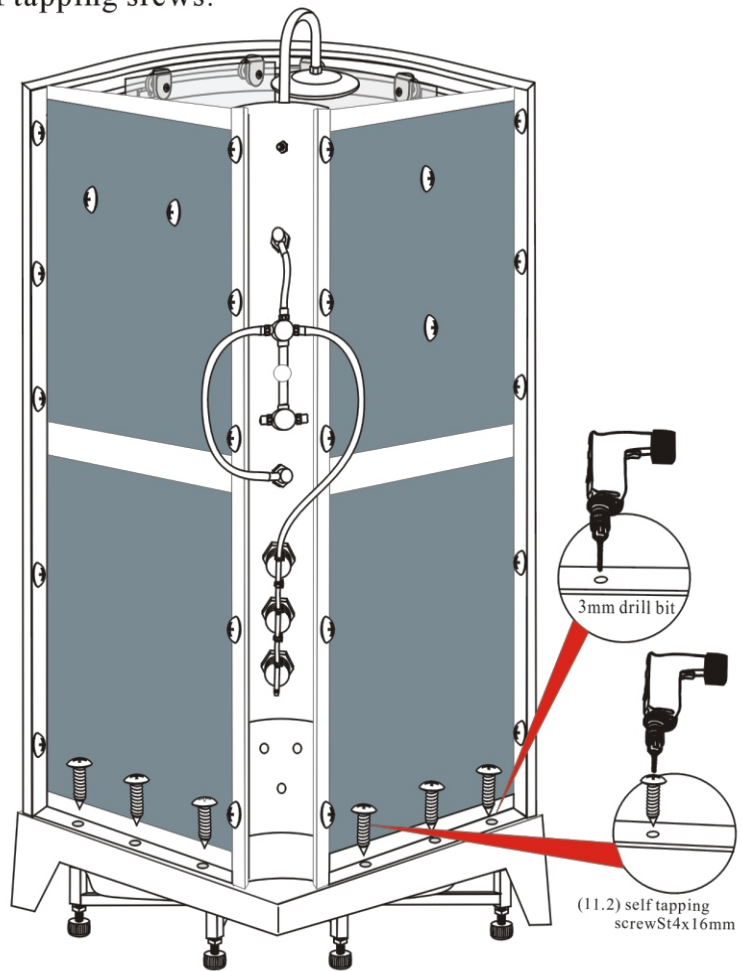

(15)

#### 4. Installation Procedure

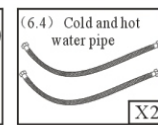

Fasten cold and hot water pipe with installed shower room with adjustable spanner, then move it to the wall angle

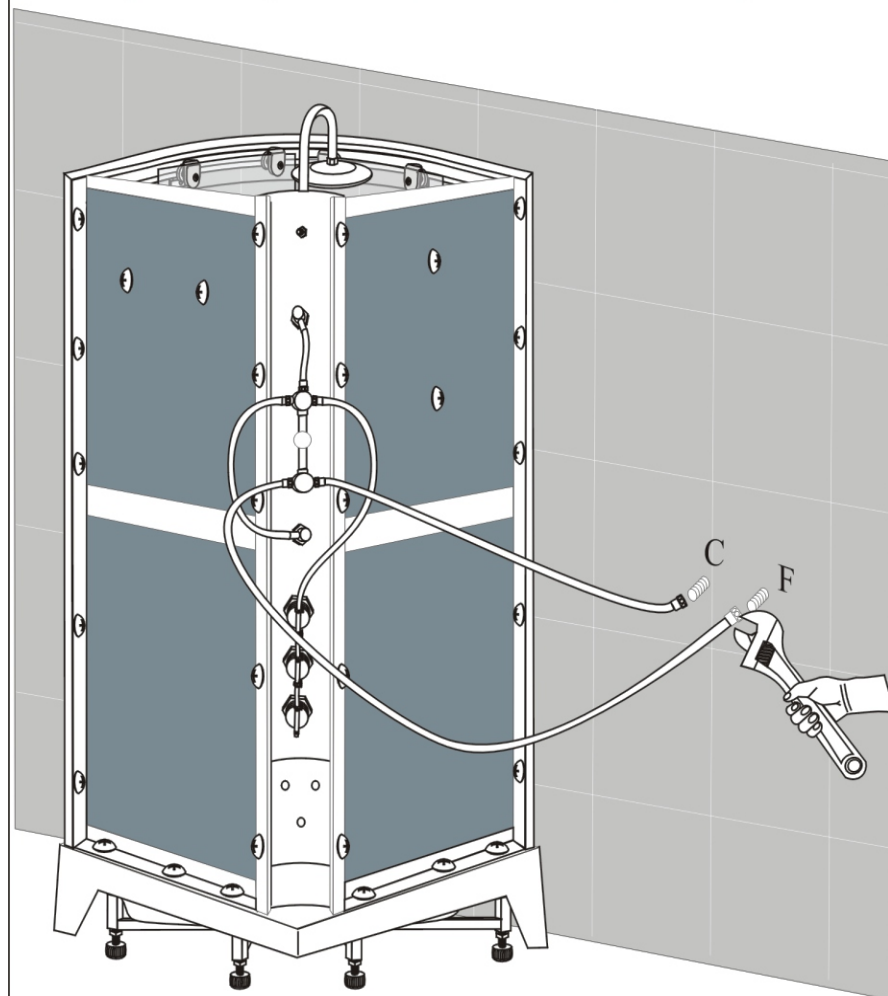

(16)

## 5: Notes

1. It is inadvisable to take a shower after drunk.
2. It is inadvisable to have a shower immediately after acute sports.
3. Please avoid bath or shower in morning.
4. Keep the temperature of dressing room near to the bathroom's
5. If you feel uncomfortable while having a shower, you should go out of the shower room as soon as possible.
6. The time of shower is advisable to be between 15 minutes and 20 minutes, no longer.
7. Drink water to supplement moisture after shower or bathing.
8. People who suffer from heart disease, high blood pressure, diabetes or who feel unwell or pregnant woman are inadvisable to have bathing, massage or shower.

## 6: Delivery and storage notice

It is prohibited to store organic solvent together, such as formic acid and methanol.

2. Handle with care if it needs transport. Heavy stress, mechanical impact and sharp pounding is prohibited.

3. It should keep it dry and airy and make sure there is no etchant gas.

## 7: Trouble shootings

Troble	Cause	Remedy
No head shower	1. water pressure is abnormal	Check water pressure
	2. Cold and hot water switch is closed.	Turn on the cold and hot water switch
	3. chocking nozzle	Clean
Water pipe leakage	1. Seal ring damaged	Replace seal ring
	2. Tie in don't connect well	Connect it again

If complete shower room can't work normally, please check it as compare above then obstacle avoidance. If customers can't make sure the cause of obstacle or lack of ability maintenance. Please contact distributor.